

Series **TT03**

---

DIGITAL TORQUE GAUGES

# **User's Guide**

**MARK-10**<sup>®</sup>

## Thank you...



Thank you for purchasing a Mark-10 Series TT03 digital torque gauge, designed for handheld or test stand use.

With proper usage, we are confident that you will get many years of great service with this product. Mark-10 instruments are ruggedly built for many years of service in laboratory and industrial environments.

This User's Guide provides setup, safety, and operation instructions. Dimensions and specifications are also provided. For additional information or answers to your questions, please do not hesitate to contact us. Our technical support and engineering teams are eager to assist you.

**Before use, each person who is to use a Series TT03 digital torque gauge should be fully trained in appropriate operation and safety procedures.**

## TABLE OF CONTENTS

OVERVIEW .....	2
POWER .....	3
SETUP .....	4
HOME SCREEN AND CONTROLS .....	5
OPERATING MODES .....	7
CHANGING THE UNITS .....	7
DIGITAL FILTERS .....	7
SET POINT INDICATORS .....	8
COMMUNICATIONS AND OUTPUTS .....	9
CALIBRATION .....	10
OTHER SETTINGS .....	14
SPECIFICATIONS .....	17

## 1 OVERVIEW

### 1.1 List of included items

Qty.	Part No.	Description
1	12-1049	Carrying Case
1	08-1022	AC adapter body with US, EU, or UK prong
1	08-1026	Battery (inside the gauge)
1	-	Certificate of calibration
1	09-1165	USB cable
1	-	Resource CD (USB driver, user's guides, MESUR™ Lite software, MESUR™ gauge DEMO software, User's Guide)

### 1.2 Safety / Proper Usage

#### Caution!

**Note the torque gauge's capacity before use and ensure that the capacity is not exceeded. Producing a torque greater than 150% of the gauge's capacity can damage the internal sensor. An overload can occur whether the gauge is powered on or off.**

Typical materials able to be tested include many manufactured items, such as springs, electronic components, fasteners, caps, mechanical assemblies, and many others. Items that should not be used with the gauge include potentially flammable substances or products, items that can shatter in an unsafe manner, and any other components that can present an exceedingly hazardous situation when acted upon by a force.

The following safety checks and procedures should be performed before and during operation:

1. Never operate the gauge if there is any visible damage to the AC adapter or the gauge itself.
2. Ensure that the gauge is kept away from water or any other electrically conductive liquids at all times.
3. The gauge should be serviced by a trained technician only. AC power must be disconnected and the gauge must be powered off before the housing is opened.
4. Always consider the characteristics of the sample being tested before initiating a test. A risk assessment should be carried out beforehand to ensure that all safety measures have been addressed and implemented.
5. Wear eye and face protection when testing, especially when testing brittle samples that have the potential to shatter under force. Be aware of the dangers posed by potential energy that can accumulate in the sample during testing. Extra bodily protection should be worn if a destructive failure of a test sample is possible.
6. In certain applications, such as the testing of brittle samples that can shatter, or other applications that could lead to a hazardous situation, it is strongly recommended that a machine guarding system be employed to protect the operator and others in the vicinity from shards or debris.
7. When the gauge is not in use, ensure that the power is turned off.

## 2 POWER

The TT03 is powered either by an 8.4V NiMH rechargeable battery or by an AC adapter. Since these batteries are subject to self discharge, it may be necessary to recharge the unit after a prolonged period of storage. Plug the accompanying charger into the AC outlet and insert the charger plug into the receptacle on the gauge (refer to the illustration below). The battery will fully charge in approximately 8 hours.

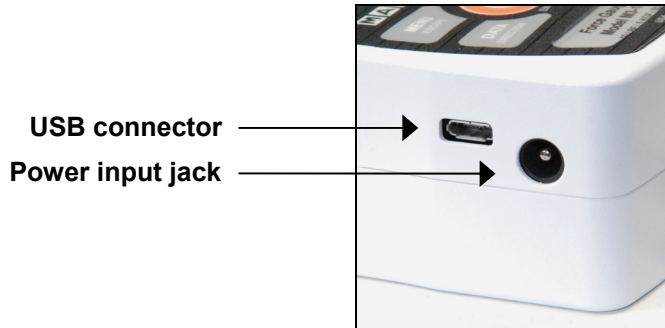





### Caution!

**Do not use chargers or batteries other than supplied or instrument damage may occur.**

If the AC adapter is plugged in, an icon appears in the lower left corner of the display, as follows: 

If the AC adapter is not plugged in, battery power drainage is denoted in a five-step process:

1. When battery life is greater than 75%, the following indicator is present: 
2. When battery life is between 50% and 75%, the following indicator is present: 
3. When battery life is between 25% and 50%, the following indicator is present: 
4. When battery life is less than 25%, the following indicator is present: 
5. When battery life drops to approximately 2%, the indicator from step 4 will be flashing. Several minutes after (timing depends on usage and whether the backlight is turned on or off), a message appears, "BATTERY VOLTAGE TOO LOW. POWERING OFF". A 4-tone audio indicator will sound and the gauge will power off.

The gauge can be configured to automatically power off following a period of inactivity. Refer to the **Other Settings** section for details.

If battery replacement is necessary, the battery may be accessed by loosening the two captive screws in the rear half of the housing and separating the two halves of the housing.

## 3 SETUP

### 3.1 Mechanical Setup

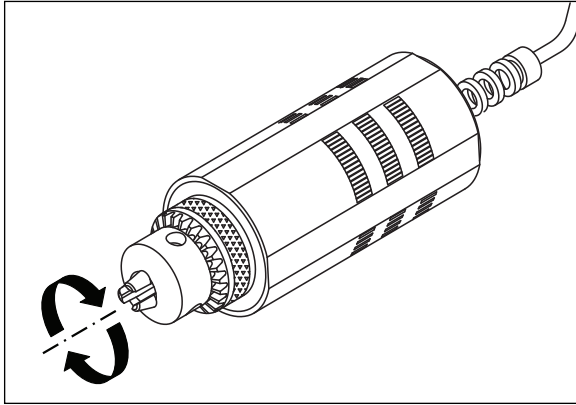

Fig. 3.1  
Proper axial loading of Series TT03 torque gauge.

#### 3.1.1 Proper alignment

Load must be applied axially with respect to the sensor, as shown in Figure 3.1. If attachments are used, ensure that the sample is acted upon axially with respect to the instrument. Side loading or off-center loading can damage the instrument, whether power is turned on or off.

#### 3.1.2 Mounting to a plate

The indicator portion of the gauge can be mounted to a plate with four thumb screws fastened into the appropriate holes in the rear half of the housing.

The torque sensor portion of the gauge (shown in Figure 3.1) can be mounted directly to a Mark-10 torque test stand or tabletop mounting kit without the need for any additional adapters. Flat surfaces are provided to prevent rotation within a fixture.

Refer to the **Dimensions** section for detailed information.

### 3.2 Installing the USB driver

If communicating via USB, install the USB driver provided on the Resource CD. Installation instructions may also be found on the CD or may be downloaded from [www.mark-10.com](http://www.mark-10.com).

#### **Caution!**

***Install the USB driver before physically connecting the gauge to a PC with the USB cable.***



Further instructions for configuring and using the gauge's outputs are provided in the **Communications and Outputs** section.

## 4 HOME SCREEN AND CONTROLS

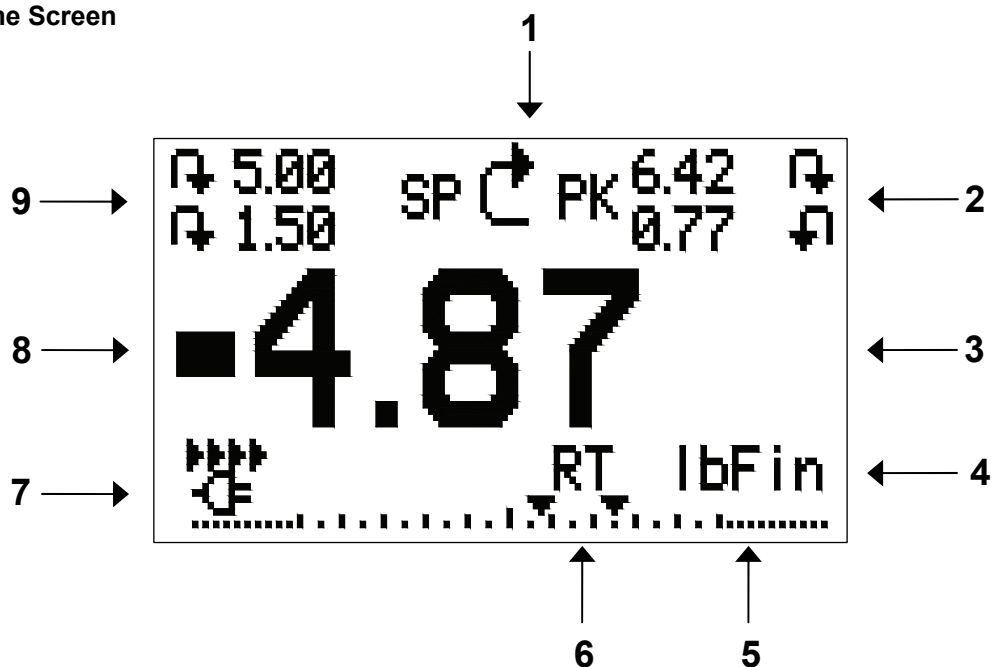

### 4.1 Home Screen



No.	Name	Description
1	Measurement direction indicator	<ul style="list-style-type: none"> <li>↻ – indicates clockwise direction</li> <li>↺ – indicates counter-clockwise direction</li> </ul> These indicators are used throughout the display and menu.
2	Peaks	The maximum measured clockwise and counter-clockwise readings. These readings are reset by pressing <b>ZERO</b> or by powering the gauge off and on.
3	Primary reading	The current displayed load reading. See <b>Operating Modes</b> section for details.
4	Load bar	Analog indicator to help identify when an overload condition is imminent. The bar increases either to the right or to the left from the midpoint of the graph. Increasing to the right indicates clockwise load, increasing to the left indicates counter-clockwise load. If set points are enabled, triangular markers are displayed for visual convenience. This indicator reflects the actual load, which may not correspond to the primary reading (depends on operating mode). The <b>ZERO</b> key does not reset the load bar. See <b>Operating Modes</b> section for details.
5	Units	The current measurement unit. Abbreviations are as follows: <ul style="list-style-type: none"> <li>lbFin – Pound-inch</li> <li>ozFin – Ounce-inch</li> <li>kgFmm – Kilogram-millimeter</li> <li>Ncm – Newton-centimeter</li> </ul> <b>Note:</b> not all sensor models display all the above units. Refer to the capacity / resolution table for details.
6	Mode	The current measurement mode. Abbreviations are as follows: <ul style="list-style-type: none"> <li>RT – Real Time</li> <li>PCW – Peak Clockwise</li> <li>PCCW – Peak Counter-clockwise</li> </ul> See <b>Operating Modes</b> section for details about each of these modes
7	Battery / AC adapter indicator	Either the AC adapter icon or battery power icon will be shown, depending on power conditions. Refer to the <b>Power</b> section for details.

8	<b>High / low limit indicators</b>	Correspond to the programmed set points. Indicator definitions are as follows:  – the displayed value is greater than the upper load limit  – the displayed value is between the load limits  – the displayed value is less than the lower load limit
9	<b>Set points</b>	The programmed load limit values. Typically used for pass/fail type testing. One, two, or no indicators may be present, depending on the configuration shown in the <b>Set Points</b> menu item.

## 4.2 Controls

Primary Label	Primary Function	Secondary Label	Secondary Function
	Powers the gauge on and off. Press briefly to power on, press and hold to power off. Active only when the home screen is displayed.	<b>ENTER</b>	Various uses, as described in the following sections.
<b>ZERO</b>	Zeroes the primary reading and peaks.	 (UP)	Navigates up through the menu and sub-menus .
<b>MENU</b>	Enters the main menu.	<b>ESCAPE</b>	Reverts one step backwards through the menu hierarchy.
<b>MODE</b>	Toggles between measurement modes.	 (DOWN)	Navigates down through the menu and sub-menus.
<b>DATA</b>	Transmits the current reading to an external device via the USB port.	<b>DIRECTION</b>	Toggles between clockwise and counter-clockwise directions while configuring set points and other menu functions.

**Note:** Measurement units are configured through the menu. Refer to **Changing The Units** section for details.

## 4.3 Menu navigation basics

Most of the gauge's various functions and parameters are configured through the main menu. To access the menu press **MENU**. Use the **UP** and **DOWN** keys to scroll through the items. The current selection is denoted with clear text over a dark background. Press **ENTER** to select a menu item, then use **UP** and **DOWN** again to scroll through the sub-menus. Press **ENTER** again to select the sub-menu item.

For parameters that may be either selected or deselected, press **ENTER** to toggle between selecting and deselecting. An asterisk (\*) to the left of the parameter label is used to indicate when the parameter has been selected.

For parameters requiring the input of a numerical value, use the **UP** and **DOWN** keys to increment or decrement the value. Press and hold either key to auto-increment at a gradually increasing rate. When the desired value has been reached, press **ENTER** to save the change and revert back to the sub-menu item, or press **ESCAPE** to revert back to the sub-menu item without saving. Press **ESCAPE** to revert one step back in the menu hierarchy until back into normal operating mode.

Refer to the following sections for details about setting up particular functions and parameters.

## 5 OPERATING MODES

---

### Caution!

In any operating mode, if the capacity of the instrument has been exceeded by more than 110%, the display will show "OVER" to indicate an overload. A continuous audible tone will be sounded (if beeps are enabled) until the MENU key has been pressed or the load has been reduced to a safe level.

Three operating modes are possible with the TT03 torque gauge. To cycle between the modes, press **MODE** while in the home screen.

#### 5.1 Real time (RT)

The primary reading corresponds to the live measured reading.

#### 5.2 Peak Clockwise (PCW)

The primary reading corresponds to the peak clockwise reading observed. If the actual load decreases from the peak value, the peak will still be retained in the primary reading area of the display. Pressing **ZERO** will reset the value.

#### 5.3 Peak Counter-clockwise (PCCW)

Same as above, but for counter-clockwise readings.

## 6 CHANGING THE UNITS

---

The TT03 can display three different measurement units, depending on the model. To change the unit, select **Units** from the menu. The display will list the available units, for example:

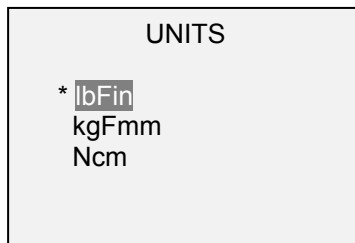

The gauge will always power on with the unit selected.

## 7 DIGITAL FILTERS

---

Digital filters are provided to help smooth out the readings in situations where there is mechanical interference in the work area or test sample. These filters utilize the moving average technique in which consecutive readings are pushed through a buffer and the displayed reading is the average of the buffer contents. By varying the length of the buffer, a variable smoothing effect can be achieved. The selection of 1 will disable the filter since the average of a single value is the value itself.

To access digital filter settings, select **Filters** from the menu. The display appears as follows:



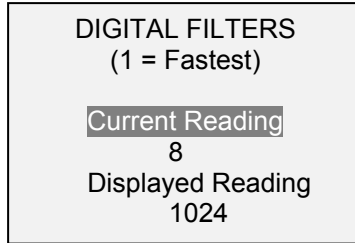

Two filters are available:

**Current Reading** – Applies to the peak capture rate of the instrument.

**Displayed Reading** – Applies to the primary reading on the display.

Available settings: 1, 2, 4, 8, 16, 32, 64, 128, 256, 512, 1024. It is recommended to keep the current reading filter at its lowest value for best performance, and the displayed reading filter at its highest value for best stability.

## 8 SET POINT INDICATORS

### 8.1 General Information

Set points are useful for tolerance checking (pass/fail). Two limits, high and low, are specified and stored in the non-volatile memory of the instrument and the primary reading is compared to these limits.

### 8.2 Configuration

To configure set points, select **Set Points** from the menu. The screen appears as follows:

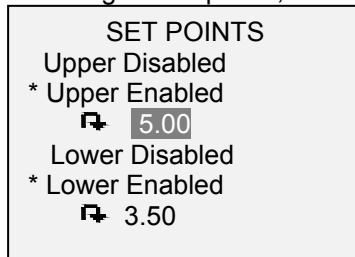

Either one, two, or none of the set points may be enabled. To toggle between the clockwise and counter-clockwise directions, press the **DIRECTION** key.

If two set points have been enabled, they are displayed in the upper left corner of the display. If only one set point has been enabled, the word "OFF" appears in place of the value. If no set points have been enabled, the upper left corner of the display will be blank. When set points are enabled, the following indicators are shown to the left of the primary reading:

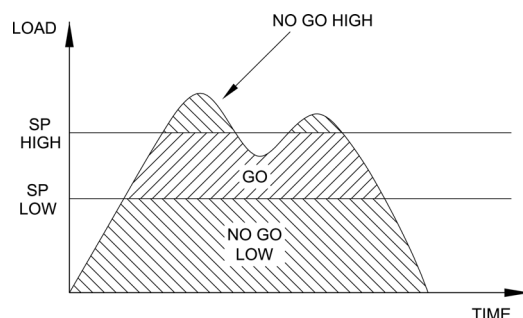

- ▲ – the displayed value is greater than the upper load limit (NO GO HIGH)
- – the displayed value is between the limits (GO)
- ▼ – the displayed value is less than the lower load limit (NO GO LOW)

**Note:** Set point indicators reference the displayed reading, not necessarily the current live load.

## 9 COMMUNICATIONS AND OUTPUTS

### 9.1 Communication Settings

To set up communication settings, select **USB Settings** from the menu. The screen appears as follows:

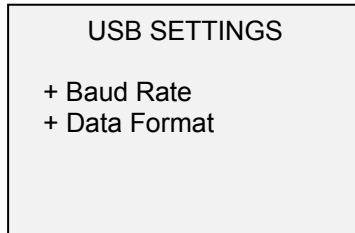

Communication settings are permanently set to the following:

**Data Bits:** 8  
**Stop Bits:** 1  
**Parity:** None

Other settings are configured as follows:

#### 9.1.1 Baud Rate

Select the baud rate as required for the application. It must be set to the same value as the receiving device.

#### 9.1.2 Data Format

Select the desired data format. The screen appears as follows:

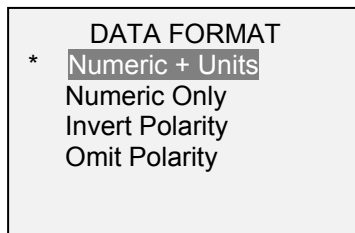

Selection	Description
Numeric + Units	Output format includes the value and unit of measure. Clockwise values have positive polarity, counter-clockwise values have negative polarity.
Numeric Only	Output format includes the value only. Polarity same as above.
Invert Polarity	Clockwise values have negative polarity, counter-clockwise values have positive polarity. May be selected in addition to the Numeric + Units / Numeric Only selection.
Omit Polarity	Both directions are formatted with positive polarity. May be selected in addition to the Numeric + Units / Numeric Only selection.

### 9.2 Data Output

Communication with Series TT03 torque gauges is achieved through the micro USB port located along the left side of the housing, as shown in the illustration in the **Power** section. Communication is possible only when the gauge is in the main operating screen (i.e. not in a menu or configuration area).

The current reading is transmitted from the gauge when the **DATA** key is pressed. Series TT03 gauges may also be controlled by an external device through the USB channel by sending ASCII command '?'

(no quotes). The command must be terminated by a CR (Carriage Return) character, 0x0D, or a CR-LF (Carriage Return – Line Feed) pair, where the Line Feed, 0x0A, is ignored.

### 9.3 Command Responses

In response to the reading request command '?' the gauge will return a string with the load data, followed by a space, then the load unit (if enabled under the **USB Settings** → **Data format** sub-menu). It will be terminated by a CR-LF pair.

Example return strings:

-18.78 lbFin<CR><LF>    18.78 lbFin of counter-clockwise torque  
4.285 Nm<CR><LF>        4.285 Nm of clockwise torque

The number of digits after the decimal point is dependent of the gauge's capacity and resolution.

Polarity may be inverted or omitted, as shown in the table above.

Any detected errors are reported back by means of error code \*10 (illegal command).

Series TT03 gauges can send individual data points or continuous data to *MESUR™gauge* and *MESUR™ Lite* software.

## 10 CALIBRATION

### 10.1 Initial Physical Setup

The sensor should be mounted vertically to a test stand or fixture rugged enough to withstand a load equal to the full capacity of the instrument. Vertical orientation is preferable to avoid side loading, which can affect the readings. Suitable certified calibration equipment is required, and caution should be taken while handling such equipment.

The illustration below depicts a recommended vertical setup:

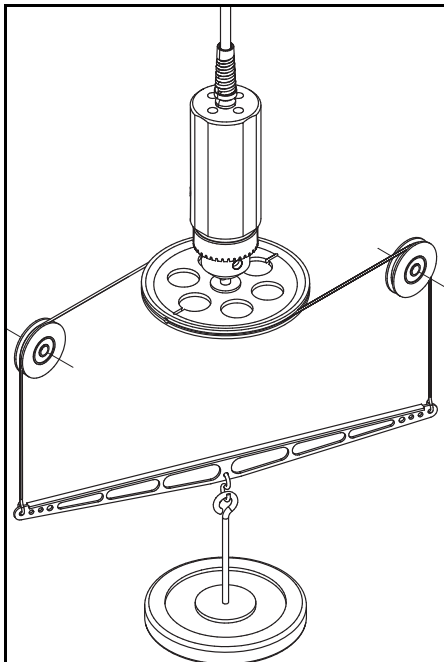

## 10.2 Calibration Procedure

1. Select **Calibration** from the menu. The display appears as follows:

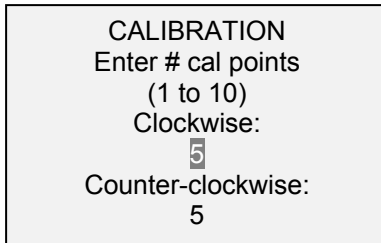

The sensor can be calibrated at up to 10 points in each direction. Enter the number of calibration points for each direction. At least one point must be selected for each direction.

**Note:** To achieve the accuracy specification of  $\pm 0.5\%$  of full scale, it is recommended to calibrate the sensor at 5 or more even increments in both the clockwise and counter-clockwise directions. For example, a sensor with capacity of 50 lbFin should be calibrated at 10, 20, 30, 40, and 50 lbFin loads in each direction.

2. To escape the **Calibration** menu at any time, press **ESCAPE**. The display appears as follows:

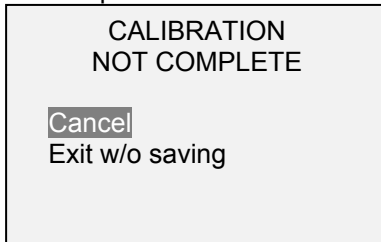

Selecting "CANCEL" will revert back to the Calibration setup. Selecting "EXIT W/O SAVING" will return to the menu without saving changes.

3. After the number of calibration points has been entered, press **ENTER**. The display appears as follows:

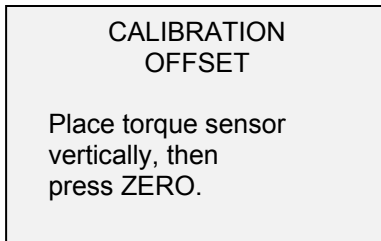

4. Place the torque sensor vertically in a fixture free from vibration, then press **ZERO**. The gauge will calculate offsets, and the display appears as follows:



CALIBRATION  
OFFSET

Sensor passed  
Analog passed

If failed:

CALIBRATION  
OFFSET

Sensor failed  
Analog failed

5. The following screen appears after the offsets have been calculated:

CALIBRATION  
CLOCKWISE

Attach necessary  
weight fixtures,  
then press ENTER.

Keep the sensor in a vertical position, as explained in the previous sub-section. Attach weight fixtures (brackets, hooks, etc), as required. Do not yet attach any weights or apply any calibration loads. Then press **ENTER**.

6. The display appears as follows:

CALIBRATION  
CLOCKWISE

Optionally exercise  
sensor, then press  
ENTER.

Optionally exercise the sensor several times (at full scale, if possible), then press **ENTER**.

7. The display appears as follows:

CALIBRATION  
CLOCKWISE  
Gain adjust  
Apply full scale load  
50.00 lbFin +/-20%,  
then press ENTER.

Apply torque equal to the full scale of the instrument, then press **ENTER**.

8. After displaying "PLEASE WAIT..." the display appears as follows:

CALIBRATION  
CLOCKWISE

Ensure no load,  
then press ZERO.

Remove the torque applied in Step 7, leave the fixtures in place, then press **ZERO**.

9. The display appears as follows:

```
CALIBRATION
CLOCKWISE
Apply load
1 OF 5
Enter load:
10.00 lbFin
Press ENTER.
```

Use the **UP** and **DOWN** keys to adjust the torque value as required. The torque values default to even increments, as indicated by the previously entered number of data points described in Step 1. Then press **ENTER**.

Repeat the above step for the number of data points selected.

10. After all the clockwise calibration points have been completed, the display appears as follows:

```
CALIBRATION
CLOCKWISE COMPLETE
Reverse direction
for counter-clockwise.
Attach necessary
weight fixtures,
then press ENTER.
```

Press **ENTER**.

11. At the completion of the counter-clockwise calibration, the display appears as follows:

```
CALIBRATION
COMPLETE

Save & exit
Exit w/o saving
```

To save the calibration information, select "SAVE & EXIT". To exit without saving the data select "EXIT W/O SAVING".

12. Any errors are reported by the following screens:

```
CALIBRATION

Units must be Ncm.

Please try again
Press ENTER.
```

Displayed at the start of calibration if a disallowed unit is selected.



Ensure that the load is not swinging, oscillating, or vibrating in any manner. Then try again.

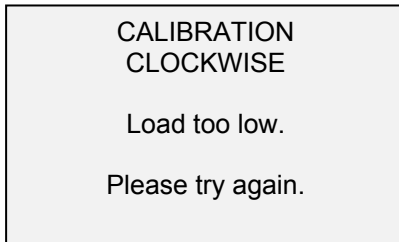

The calibration load does not match the set value.

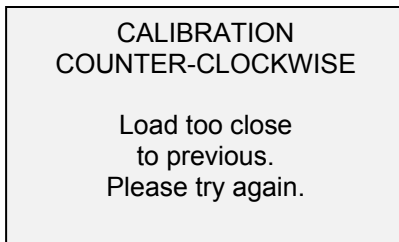

The entered calibration point is too close to the previous point.

## 11 OTHER SETTINGS

### 11.1 Automatic Shutoff

The gauge may be configured to automatically power off following a period of inactivity while on battery power. Inactivity is defined as the absence of any key presses or load changes of 100 counts or less. To access these settings, select **Automatic Shutoff** from the menu. The display appears as follows:

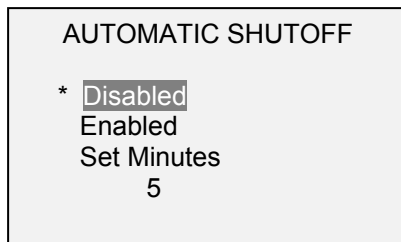

Select **Disabled** to disable automatic shutoff. Select **Enabled** to enable it. The length of time of inactivity is programmed in minutes via the **Set Minutes** parameter. Available settings: 5-30, in 5 minute increments.

**Note:** If the AC adapter is plugged in, the gauge will ignore the **Automatic Shutoff** setting and remain powered on until the **POWER** key is pressed.

### 11.2 Backlight

Several initial settings are available, upon powering on the gauge. To access these settings, select **Backlight** from the menu. The display appears as follows:



Selection	Description
<b>Off</b>	Backlight to be off upon powering on the gauge.
<b>On</b>	Backlight to be on upon powering on the gauge.
<b>Auto</b>	Backlight to be on upon powering gauge, but will shut off after a period of inactivity (as defined in the <b>Automatic Shutoff</b> sub-section). The backlight will turn on again when activity resumes. The length of time of inactivity is programmed in minutes via the <b>Set Minutes</b> parameter. Available settings: 1-10, in 1 minute increments.

**Note:** If the AC adapter is plugged in, the gauge will ignore these settings and keep the backlight on. Selecting the **On** or **Off** setting in the **Backlight** menu will manually turn the backlight on or off as if the Backlight key were pressed.

### 11.3 LCD Contrast

The contrast of the display may be adjusted. Select **LCD Contrast** from the menu. The screen appears as follows:



Press **ENTER** to modify the contrast. Select a value from 0 to 25, 25 producing the most contrast.

### 11.4 Tones

Audible tones can be enabled for all key presses and alerts, such as overload, set point value reached, etc. The Set Point alert can be configured to be either a momentary tone or a continuous tone (until the load is restored to a value between the set points). To configure the functions for which audible tones will apply, select **Tones** from the menu. The screen appears as follows:

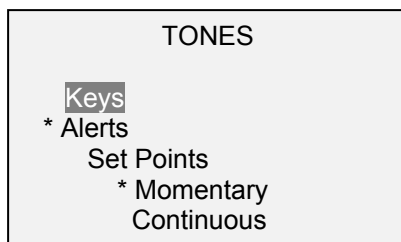

### 11.5 Initial Mode

This section is used to configure the initial mode upon powering on the gauge. To access this parameter, select **Initial Mode** from the menu. The screen will display the available modes. An example is as follows:



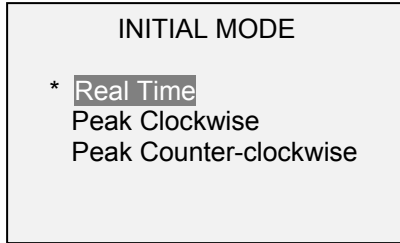

The default value is Real Time.

### 11.6 Restore Default Settings

Default factory settings can be restored by selecting **Restore Defaults** from the menu. The settings may be found in the **Specifications** section. The screen appears as follows:



### 11.7 Information / Welcome Screen

The following screen is displayed at power up and can be accessed at any time by selecting **Information** from the menu:

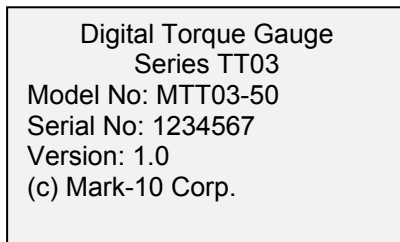

## 12 SPECIFICATIONS

### 12.1 General

<b>Accuracy:</b>	±0.5% of full scale
<b>Sampling rate:</b>	2,000 Hz
<b>Power:</b>	AC or rechargeable battery. Low battery indicator appears when battery level is low, and gauge powers off automatically when power reaches critical stage.
<b>Battery life:</b>	<b>Backlight on:</b> up to 7 hours of continuous use <b>Backlight off:</b> up to 24 hours of continuous use
<b>Measurement units:</b>	lbFin, ozFin, kgFmm, Ncm (depending on model)
<b>USB output:</b>	Individual data point output by pressing DATA button. Configurable up to 115,200 baud.
<b>Safe overload:</b>	150% of full scale (display shows "OVER" at 110% and above)
<b>Weight:</b>	1.8 lb [0.8 kg]
<b>Included accessories:</b>	Carrying case, AC adapter, battery, USB cable, resource CD (USB driver, MESUR™ Lite software, MESUR™ gauge DEMO software, and user's guide), NIST-traceable certificate of calibration
<b>Environmental requirements:</b>	40 - 100°F, max. 96% humidity, non-condensating
<b>Warranty:</b>	3 years (see individual statement for further details)

## 12.2 Factory Settings

Parameter	Setting
Set points	
Upper	Disabled (defaults to 80% of full scale, clockwise, when enabled)
Lower	Disabled (defaults to 40% of full scale, clockwise, when enabled)
Filters	
Current	8
Displayed	128
Backlight	Auto
Minutes	1
USB Output	Disabled
Baud Rate	9,600
Data Format	Numeric + units
Automatic Shutoff	Enabled
Minutes	5
Tones	
Keys	Enabled
Alerts	Enabled
Set Points	Momentary
Initial Mode	Real Time
Units	Depends on gauge model

## 12.3 Capacity & Resolution

Model	ozFin	lbFin	kgFmm	Ncm
MTT03-10Z	10 x 0.01	-	7 x 0.005	7 x 0.005
MTT03-20Z	20 x 0.02	-	14 x 0.01	14 x 0.01
MTT03-50Z	50 x 0.05	-	36 x 0.05	36 x 0.05
MTT03-12	192 x 0.2	12 x 0.01	-	135 x 0.1
MTT03-50	800 x 0.5	50 x 0.05	-	570 x 0.5
MTT03-100	1600 x 1	100 x 0.1	-	1150 x 1

## 12.4 Dimensions IN [MM]

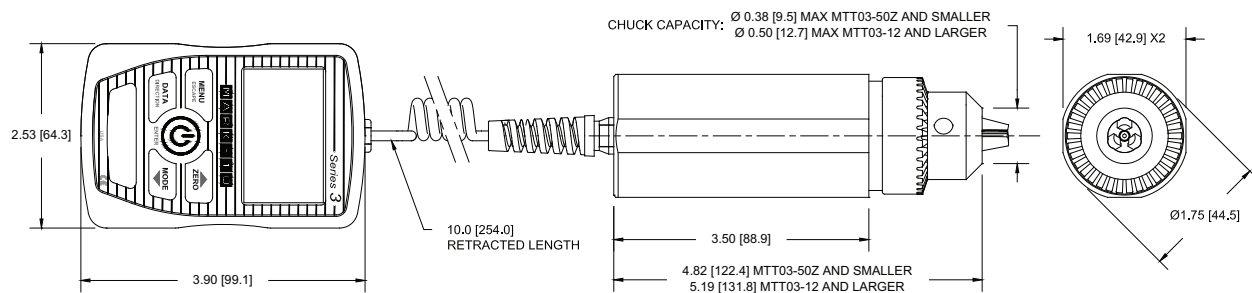



*Mark-10 Corporation has been an innovator in the force and torque measurement fields since 1979. We strive to achieve 100% customer satisfaction through excellence in product design, manufacturing and customer support. In addition to our standard line of products we can provide modifications and custom designs for OEM applications. Our engineering team is eager to satisfy any special requirements. Please contact us for further information or suggestions for improvement.*



*Force and torque measurement engineered better*

**Mark-10 Corporation**

11 Dixon Avenue  
Copiague, NY 11726 USA  
1-888-MARK-TEN  
Tel: 631-842-9200  
Fax: 631-842-9201  
Internet: [www.mark-10.com](http://www.mark-10.com)  
E-mail: [info@mark-10.com](mailto:info@mark-10.com)